



 Clean water
(Maximum sand content 100 g/m³)

 Civil use

 Agricultural use

 Industrial use

PERFORMANCE RANGE

- Flow rate up to **1500 l/min** (90 m³/h)
- Head up to **375 m**

APPLICATION LIMITS

- Maximum liquid temperature **+35 °C**
- Maximum sand content **100 g/m³**
- **200 m** immersion limit
- Installation:
 - vertical
 - horizontal, with the following limits:
 - 6HR34 up to **11 stages**
 - 6HR44 up to **10 stages**
 - 6HR54 up to **9 stages**
 - 6HR64 up to **7 stages**
- Starts/hour: **20** at regular intervals
- Minimum flow rate for motor cooling **10 cm/s**
- Continuous service **S1**

CONSTRUCTION AND SAFETY STANDARDS

ELECTRIC MOTOR

– Three-phase 400 V - 50 Hz

4 m long power cable

EN 60335-1
IEC 60335-1
CEI 61-150

EN 60034-1
IEC 60034-1
CEI 2-3



EU REGULATION N. 547/2012

CERTIFICATIONS

Company with management system certified DNV
ISO 9001: QUALITY



INSTALLATION AND USE

Suitable for use with clean water with a sand content of no more than **100 g/m³**. Because of their high efficiency and reliability, they are suitable for use in civil, agricultural and industrial applications such as the distribution of water in combination with pressure tanks, for irrigation and for pressure boosting in fire-fighting sets, etc.

PATENTS - TRADE MARKS - MODELS

Registered EU Design n. 004675106-0002

OPTIONS AVAILABLE ON REQUEST

- 6HR-HYD pumps with double cable cover suitable for dual voltage 400/690 V (star/delta)
- Other voltages or 60 Hz frequency

CHARACTERISTIC CURVES AND PERFORMANCE DATA

50 Hz n= 2900 min⁻¹

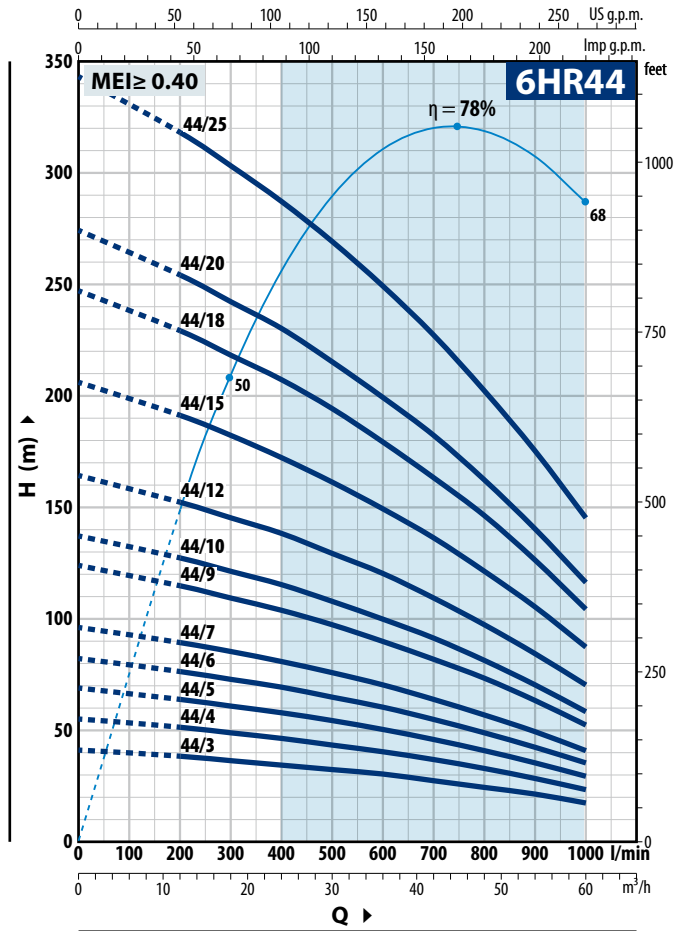
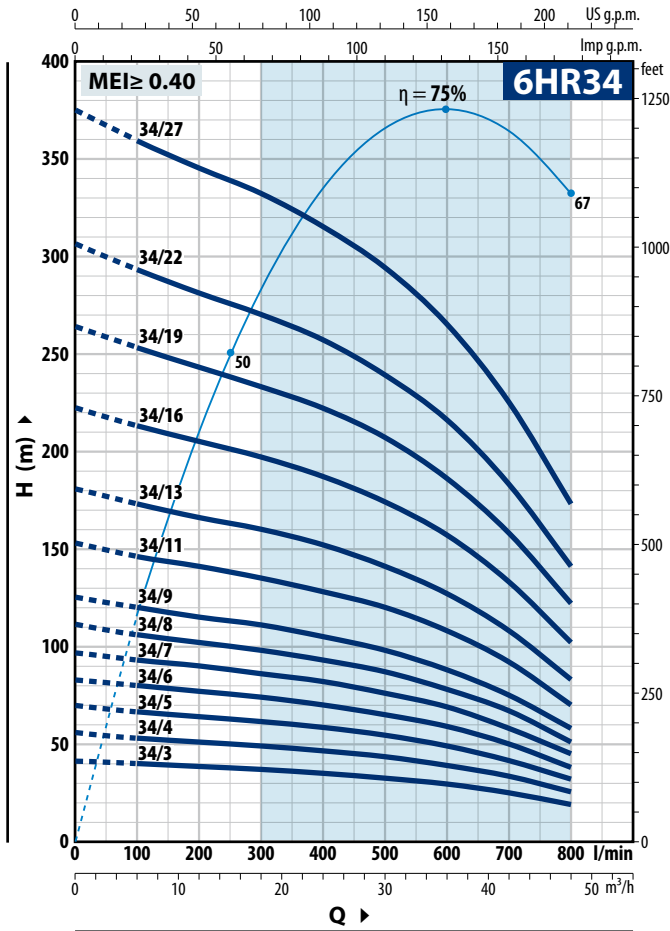

6HR34

MODEL	POWER (P ₂)		Q	Flow rate											
	kW	HP		m ³ /h	0	6	12	18	24	30	36	42	48		
Three-phase				0	100	200	300	400	500	600	700	800			
6HR 34/3	4	5.5	H metres	41.5	40	38.5	37	35	32.5	29.5	25	19			
6HR 34/4	5.5	7.5		55.5	53	51	49	46.5	43.5	39	33.5	25.5			
6HR 34/5	7.5	10		69.5	66.5	64	61.5	58.5	54.5	49	41.5	32			
6HR 34/6	9.2	12.5		83	80	77	74	70	65	59	50	38			
6HR 34/7	11	15		97	93	90	86	82	76	69	58	45			
6HR 34/8	11	15		111	106	102	98	93	87	78	67	51			
6HR 34/9	13	17.5 ⁽¹⁾		125	120	115	111	105	98	88	75	58			
6HR 34/11	15	20		153	146	141	135	128	120	108	92	70			
6HR 34/13	18.5	25		181	173	166	160	152	141	127	108	83			
6HR 34/16	22	30		222	213	205	197	187	174	157	133	102			
6HR 34/19	26	35 ⁽²⁾		264	253	243	233	222	207	186	158	122			
6HR 34/22	30	40		306	293	281	270	257	239	216	183	141			
6HR 34/27	37	50		375	359	345	332	315	294	265	225	173			

6HR44

MODEL	POWER (P ₂)		Q	Flow rate											
	kW	HP		m ³ /h	0	12	18	24	30	36	42	48	54	60	
Three-phase				0	200	300	400	500	600	700	800	900	1000		
6HR 44/3	5.5	7.5	H metres	41	38	36	34	32	30	27	24	21	17		
6HR 44/4	7.5	10		55	51	48.5	46	43	40	36.5	32.5	28	23		
6HR 44/5	7.5	10		68.5	63.5	60.5	57.5	54	50	45.5	40.5	35	29		
6HR 44/6	9.2	12.5		82	76	72.5	69	64.5	60	54.5	48.5	42	35		
6HR 44/7	11	15		96	89	85	80.5	75.5	70	63.5	56.5	49	40.5		
6HR 44/9	13	17.5 ⁽¹⁾		123.5	114.5	109	103.5	97	89.5	81.5	73	63	52		
6HR 44/10	15	20		137	127	121	115	107.5	99.5	91	81	70	58		
6HR 44/12	18.5	25		164	152	145	138	129	120	109	97	84	70		
6HR 44/15	22	30		206	191	182	172	161	149	136	121	105	87		
6HR 44/18	26	35 ⁽²⁾		247	229	218	207	194	179	163	146	126	104		
6HR 44/20	30	40		274	254	242	230	215	199	182	162	140	116		
6HR 44/25	37	50		343	318	303	287	269	249	227	202	175	145		

Q = Flow rate H = Total manometric head
 (1) Pump fitted with a 20 HP motor
 (2) Pump fitted with a 40 HP motor

Tolerance of characteristic curves in compliance with EN ISO 9906 Grade 3B.

CHARACTERISTIC CURVES AND PERFORMANCE DATA

50 Hz n = 2900 min⁻¹

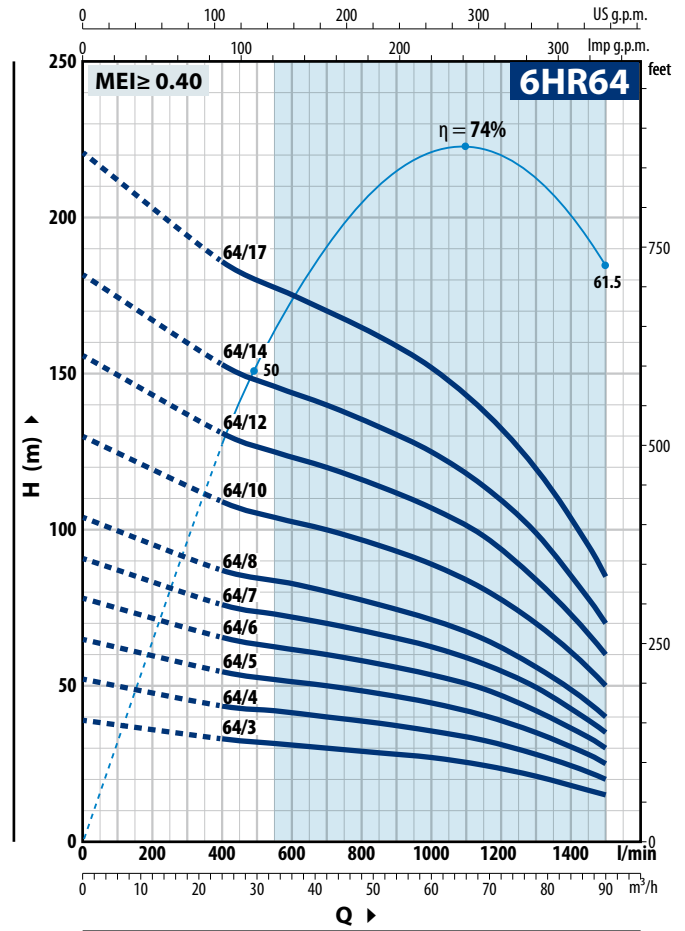
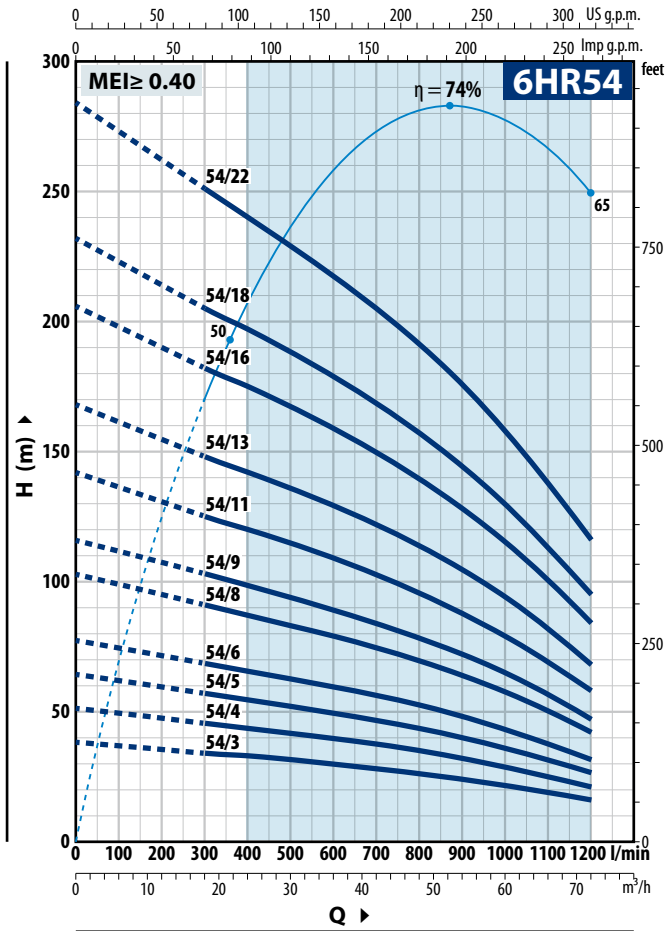

6HR54

MODEL	POWER (P ₂)		Q	Flow rate												
	kW	HP		m ³ /h	0	18	24	30	36	42	48	54	60	66	72	
Three-phase				0	300	400	500	600	700	800	900	1000	1100	1200		
6HR 54/3	5.5	7.5	H metres	38.5	34	33	31.5	29.5	28	26	24	21.5	19	16		
6HR 54/4	7.5	10		51.5	45.5	43.5	41.5	39.5	37.5	35	32	29	25	21		
6HR 54/5	9.2	12.5		64.5	57	54.5	52	49.5	46.5	43.5	40	36	31.5	26.5		
6HR 54/6	11	15		77.5	68.5	65.5	62.5	59.5	56	52.5	48	43	37.5	31.5		
6HR 54/8	13	17.5 ⁽¹⁾		103	91	87	83	79	74.5	69.5	64	57.5	50.5	42		
6HR 54/9	15	20		116	103	98	94	89	84	78	72	65	57	47		
6HR 54/11	18.5	25		142	125	120	115	109	103	96	88	79	69	58		
6HR 54/13	22	30		168	148	142	136	129	121	113	104	94	82	68		
6HR 54/16	26	35 ⁽²⁾		206	182	175	167	159	149	139	128	115	101	84		
6HR 54/18	30	40		232	205	197	188	178	168	157	144	130	113	95		
6HR 54/22	37	50		284	251	240	229	218	205	192	176	158	138	116		

6HR64

MODEL	POWER (P ₂)		Q	Flow rate										
	kW	HP		m ³ /h	0	24	33	42	51	60	69	78	87	90
Three-phase				0	400	550	700	850	1000	1150	1300	1450	1500	
6HR 64/3	7.5	10	H metres	39	33	31.5	30	28.5	27	24.5	21	16.5	15	
6HR 64/4	9.2	12.5		52	43.5	42	40	38	35.5	32.5	28	22.5	20	
6HR 64/5	11	15		65	54.5	52	50	47.5	44.5	40.5	35	28	25	
6HR 64/6	13	17.5 ⁽¹⁾		78	65.5	62.5	60	57	53.5	49	42	33.5	30	
6HR 64/7	15	20		91	76	73	70	66.5	62.5	57	49.5	39	35	
6HR 64/8	18.5	25		104	87	84	80	76	71	65	56	45	40	
6HR 64/10	22	30		130	109	104	100	95	89	81	70	56	50	
6HR 64/12	26	35 ⁽²⁾		156	131	125	120	114	107	98	84	67	60	
6HR 64/14	30	40		182	153	146	140	133	125	114	99	78	70	
6HR 64/17	37	50		221	186	178	170	162	152	138	120	95	85	

Q = Flow rate H = Total manometric head

(1) Pump fitted with a 20 HP motor

(2) Pump fitted with a 40 HP motor

Tolerance of characteristic curves in compliance with EN ISO 9906 Grade 3B.

POS. COMPONENT

CONSTRUCTION CHARACTERISTICS

1 DELIVERY BODY	Precision cast stainless steel AISI 304 complete with threaded delivery port in compliance with ISO 228/1
2 NON-RETURN VALVE	Stainless steel AISI 304
3 MOTOR BRACKET	Precision cast stainless steel AISI 304 in compliance with NEMA standards
4 IMPELLERS	Precision cast stainless steel AISI 304
5 DIFFUSERS	Precision cast stainless steel AISI 304
6 PUMP SHAFT	Stainless steel AISI 304
7 PUMP BEARINGS	Special elastomer
8 WEAR RINGS	Special elastomer
9 DRIVE COUPLING	Stainless steel AISI 304
10 FILTER	Stainless steel AISI 304
11 CABLE COVER	Stainless steel AISI 304
12 MOTOR 6"	6PD = "PEDROLLO" oil filled motor

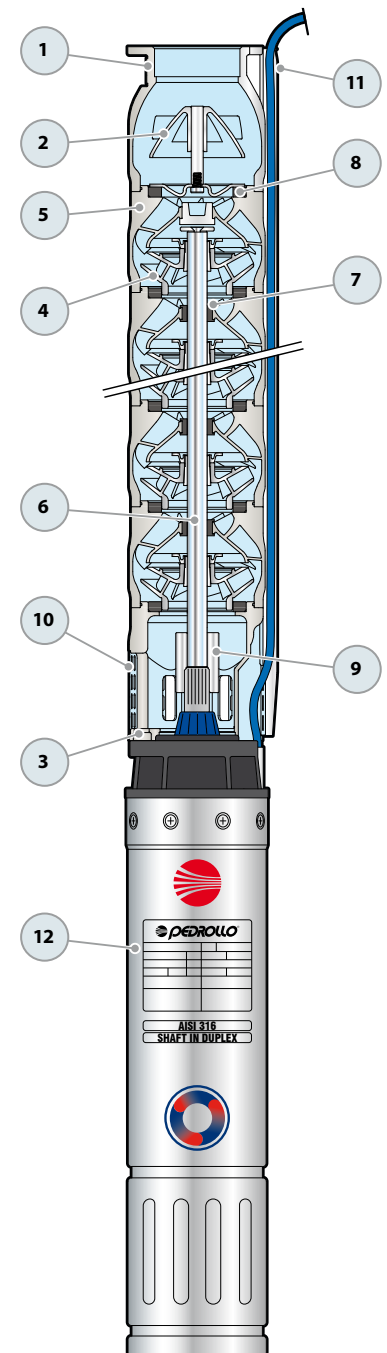

DIMENSIONS AND WEIGHT

MODEL	PORT DN	Ø	DIMENSIONS mm			kg 3~		
			h1	h2	h3			
6HR 34/3 - PD	3"	150	581	595	1176	55.4		
6HR 34/4 - PD			682	625	1307	61.1		
6HR 34/5 - PD			783	660	1443	67.5		
6HR 34/6 - PD			884	700	1584	72.9		
6HR 34/7 - PD			985	765	1750	83.2		
6HR 34/8 - PD			1086	765	1851	86.6		
6HR 34/9 - PD			1187	820	2007	98.0		
6HR 34/11 - PD			1389	820	2209	105.7		
6HR 34/13 - PD			1591	883	2474	122.4		
6HR 34/16 - PD			1894	953	2847	138.5		
6HR 34/19 - PD			2197	1098	3295	166.6		
6HR 34/22 - PD			2500	1098	3598	176.7		
6HR 34/27 - PD			3005	1233	4238	203.5		
6HR 44/3 - PD					581	625	1206	57.4
6HR 44/4 - PD					682	660	1342	64.1
6HR 44/5 - PD					783	660	1443	67.5
6HR 44/6 - PD					884	700	1584	72.9
6HR 44/7 - PD					985	765	1750	83.2
6HR 44/9 - PD					1187	820	2007	98.0
6HR 44/10 - PD					1288	820	2108	102.3
6HR 44/12 - PD					1490	883	2373	119.0
6HR 44/15 - PD					1793	953	2746	135.1
6HR 44/18 - PD					2096	1098	3194	163.2
6HR 44/20 - PD					2298	1098	3396	169.9
6HR 44/25 - PD					2803	1233	4036	196.8
6HR 54/3 - PD					599	625	1224	57.5
6HR 54/4 - PD					706	660	1366	64.3
6HR 54/5 - PD					813	700	1513	69.7
6HR 54/6 - PD					920	765	1685	80.2
6HR 54/8 - PD					1134	820	1954	95.0
6HR 54/9 - PD					1241	820	2061	99.4
6HR 54/11 - PD					1455	883	2338	116.2
6HR 54/13 - PD			1669	953	2622	129.1		
6HR 54/16 - PD			1990	1098	3088	156.3		
6HR 54/18 - PD			2204	1098	3302	164.1		
6HR 54/22 - PD			2632	1233	3865	187.8		
6HR 64/3 - PD			599	660	1259	57.2		
6HR 64/4 - PD			706	700	1406	63.9		
6HR 64/5 - PD			813	765	1578	69.2		
6HR 64/6 - PD			920	820	1740	79.6		
6HR 64/7 - PD			1027	820	1847	90.9		
6HR 64/8 - PD			1134	883	2017	94.2		
6HR 64/10 - PD			1348	953	2301	111.8		
6HR 64/12 - PD			1562	1098	2660	124.4		
6HR 64/14 - PD			1776	1098	2874	147.1		
6HR 64/17 - PD			2097	1233	3330	159.0		

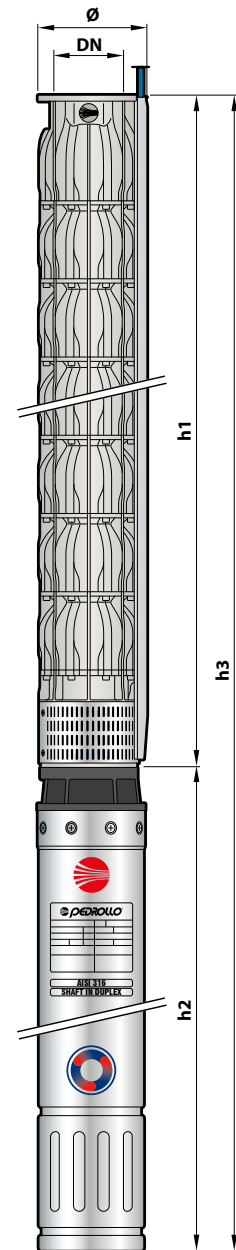

COUNTERFLANGE KIT (TO BE ORDERED SEPARATELY)

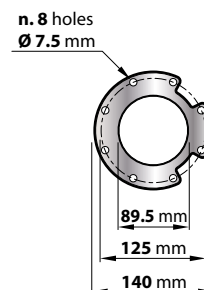

Kit consisting of:
counterflange, seal, screws and nuts

DIMENSIONS AND WEIGHT (PUMP ONLY)

MODEL Pump	PORT DN	DIMENSIONS mm		kg 3~		
		Ø	h1			
6HR 34/3 - HYD	3"	150	581	21.8		
6HR 34/4 - HYD			682	25.1		
6HR 34/5 - HYD			783	28.5		
6HR 34/6 - HYD			884	32.5		
6HR 34/7 - HYD			985	35.8		
6HR 34/8 - HYD			1086	39.2		
6HR 34/9 - HYD			1187	42.6		
6HR 34/11 - HYD			1389	49.7		
6HR 34/13 - HYD			1591	56.4		
6HR 34/16 - HYD			1894	69.5		
6HR 34/19 - HYD			2197	80.6		
6HR 34/22 - HYD			2500	90.7		
6HR 34/27 - HYD			3005	108.5		
6HR 44/3 - HYD					581	21.8
6HR 44/4 - HYD					682	25.1
6HR 44/5 - HYD					783	28.5
6HR 44/6 - HYD					884	32.5
6HR 44/7 - HYD					985	35.8
6HR 44/9 - HYD					1187	42.6
6HR 44/10 - HYD					1288	46.3
6HR 44/12 - HYD					1490	53.0
6HR 44/15 - HYD					1793	66.1
6HR 44/18 - HYD					2096	77.2
6HR 44/20 - HYD					2298	83.9
6HR 44/25 - HYD					2803	101.8
6HR 54/3 - HYD					599	21.9
6HR 54/4 - HYD					706	25.3
6HR 54/5 - HYD					813	28.7
6HR 54/6 - HYD					920	32.8
6HR 54/8 - HYD					1134	39.6
6HR 54/9 - HYD					1241	43.0
6HR 54/11 - HYD					1455	50.2
6HR 54/13 - HYD					1669	57.1
6HR 54/16 - HYD					1990	70.3
6HR 54/18 - HYD					2204	78.1
6HR 54/22 - HYD					2632	92.8
6HR 64/3 - HYD			599	21.6		
6HR 64/4 - HYD			706	24.9		
6HR 64/5 - HYD			813	28.2		
6HR 64/6 - HYD			920	32.2		
6HR 64/7 - HYD			1027	35.5		
6HR 64/8 - HYD			1134	38.8		
6HR 64/10 - HYD			1348	45.8		
6HR 64/12 - HYD			1562	52.4		
6HR 64/14 - HYD			1776	62.1		
6HR 64/17 - HYD			2097	73.0		

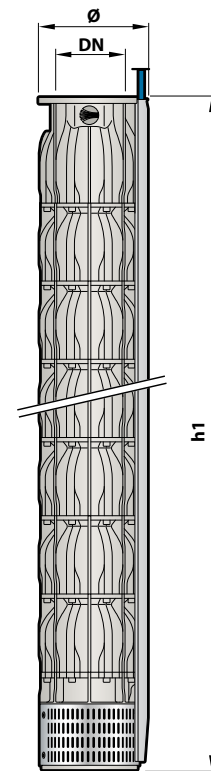

COUNTERFLANGE KIT (TO BE ORDERED SEPARATELY)

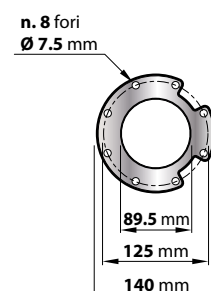

Kit consisting of:
counterflange, seal, screws and nuts